









## Botole per la manutenzione

### Revisione

Montare la vasca idromassaggio in modo che tutti i gruppi rimangano accessibili (pompa, ventola e comando). Per facilitare la revisione si consiglia il montaggio con un pannello di rivestimento rimovibile.

### Posizionamento dei componenti dei sistemi idromassaggio

Le figure mostrano la configurazione standard dei componenti del sistema idromassaggio\* con posizionamento dell'unità di comando. Dalla parte della testa si trova il massaggio dorsale (a seconda del sistema idromassaggio).

Versione speciale su richiesta. Per questo caso è necessario un disegno che mostri la disposizione desiderata. La realizzazione della disposizione desiderata verrà verificata e confermata da Duravit.

#### Blue Moon

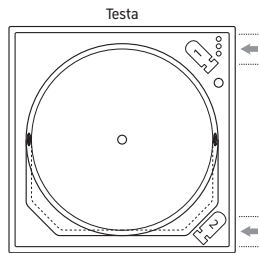

# 760143

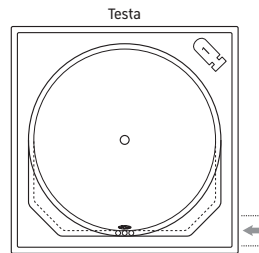

# 760402

#### Cape Cod

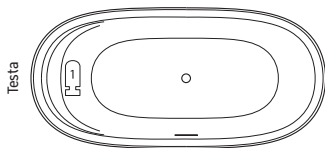

# 760330

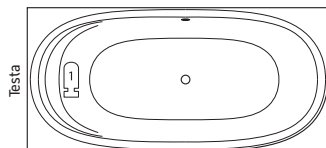

# 760362

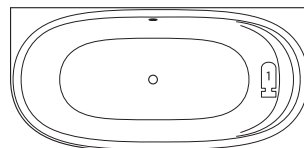

# 760363

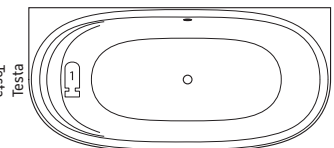

# 760364

#### Darling New

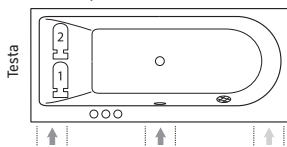

# 760238, # 760240, # 760242

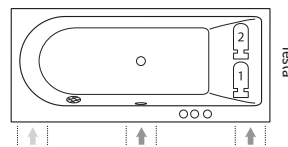

# 760239, # 760241, # 760243

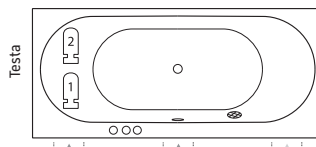

# 760244, # 760245

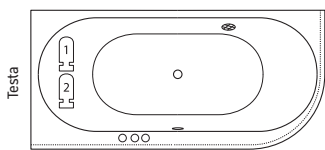

# 760246

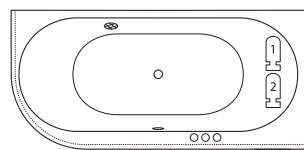

# 760247

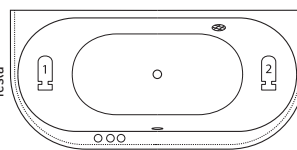

# 760248

#### D-Code

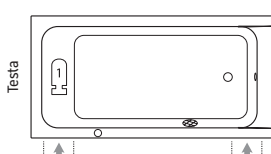

# 760095, # 760096,  
# 760098, # 760100

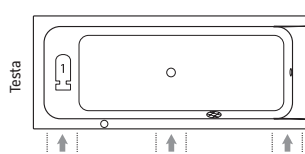

# 760097, # 760099

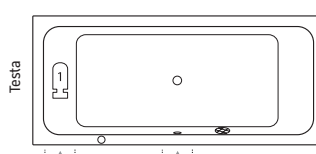

# 760101

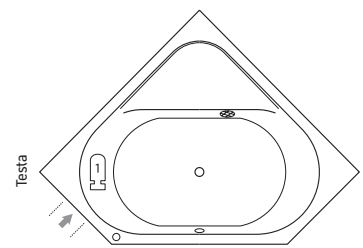

# 760137

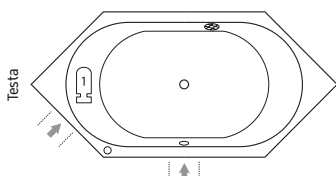

# 760138

\* Nota: a seconda della combinazione di vasca e sistema idromassaggio, alcuni componenti del sistema possono sporgere oltre il bordo della vasca. Per questo motivo si consiglia l'installazione in un telaio della vasca

### DuraSquare

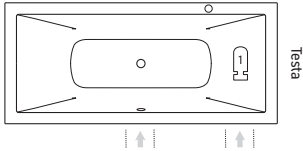

# 760426

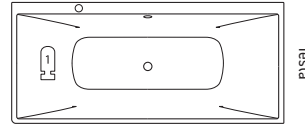

# 760427

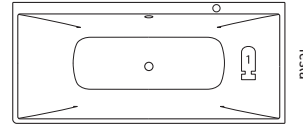

# 760428, # 760429

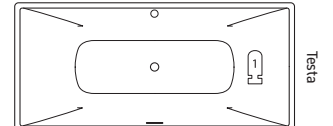

# 760430

### DuraStyle

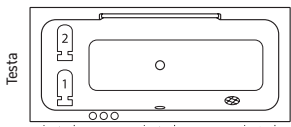

# 760292, # 760294, # 760296

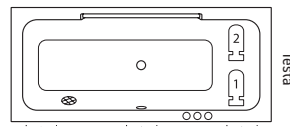

# 760293, # 760295, # 760297

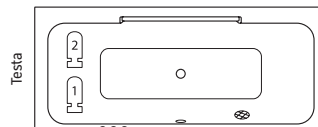

# 760298, # 760299

### Happy D.2

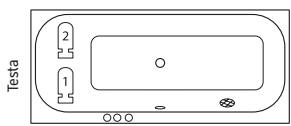

# 760308, # 760310, # 760312

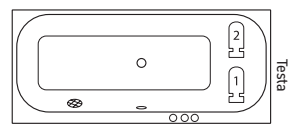

# 760309, # 760311, # 760313

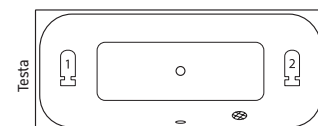

# 760314, # 760315

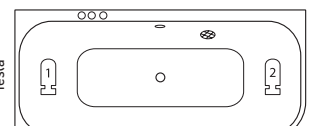

# 760316

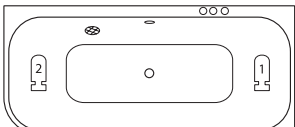

# 760317

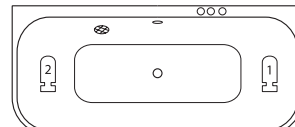

# 760318

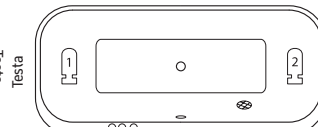

# 760319

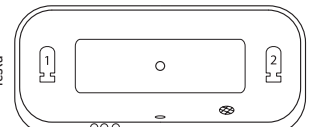

# 760320

### Happy D.2 Plus

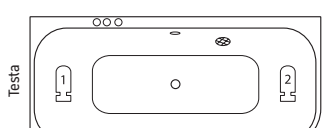

# 760449

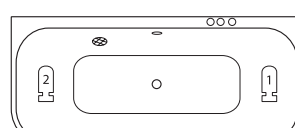

# 760450

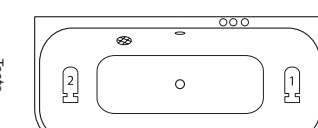

# 760451

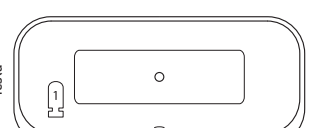

# 760453

### Luv

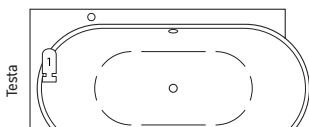

# 760431

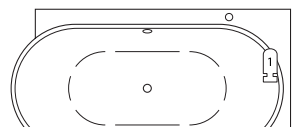

# 760432

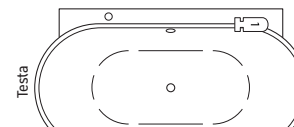

# 760433

### P3 Comforts

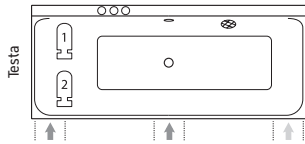

# 760371, # 760373, # 760375

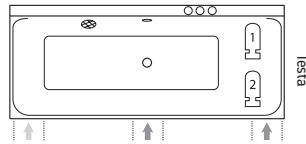

# 760372, # 760374, # 760376

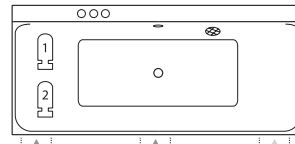

# 760377, # 760378

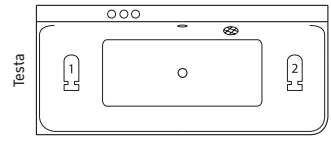

# 760379

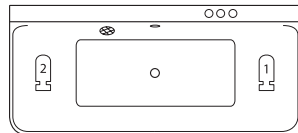

# 760380

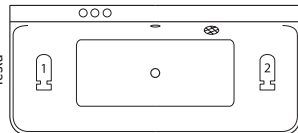

# 760381

### Paiova

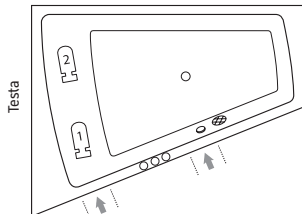

# 760212, # 760214, # 760216

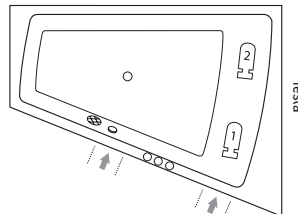

# 760213, # 760215, # 760217

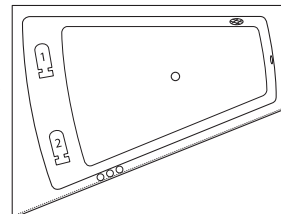

# 760264, # 760266, # 760268

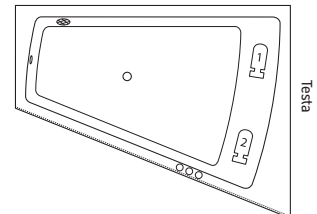

# 760265, # 760267, # 760269

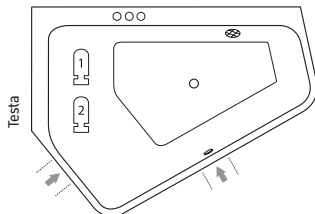

# 760390, # 760392

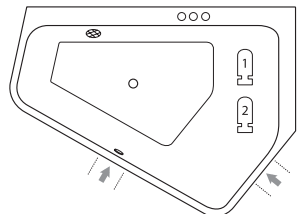

# 760391, # 760393

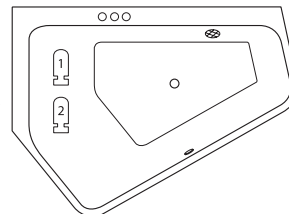

# 760394, # 760396

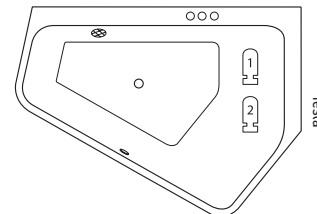

# 760395, # 760397

### Starck

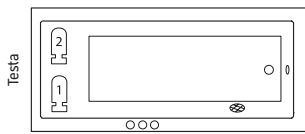

# 760050, # 760331, # 760332,  
# 760333, # 760334, # 760335,  
# 760336, # 760337

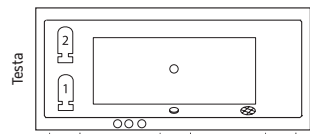

# 760052, # 760338, # 760339,  
# 760340, # 760341

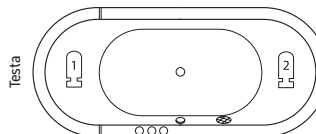

# 760009

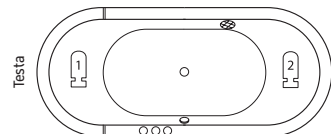

# 760010

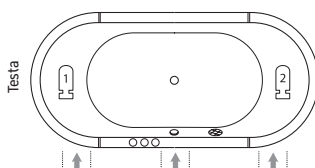

# 760011

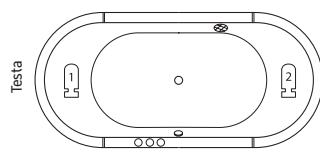

# 760012

### Vero Air

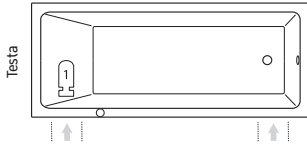

# 760411, # 760412

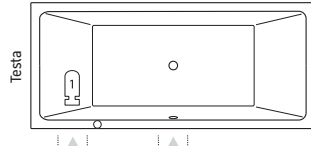

# 760413, # 760414

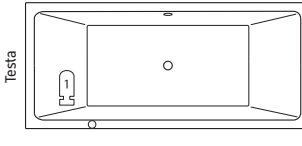

# 760415, # 760416, # 760417,  
# 760418

### Vero

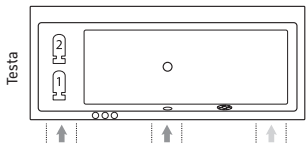

# 760133

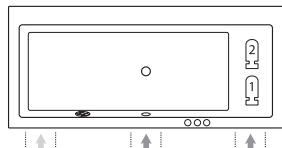

# 760134

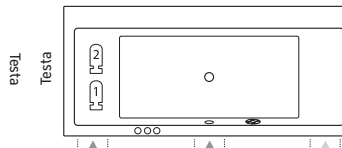

# 760135, # 760136

### Legenda



Gruppo 1



Gruppo 2\*



Unità di comando\*\*



Apertura di  
aspirazione



Pulsante  
a trazione



Modulo ru-  
binetteria



Botole richieste per  
la manutenzione



Botole richieste per  
la manutenzione\*\*\*

\* Solo Sistemi Combi / \*\* La quantità di elementi di comando dipende dal sistema idromassaggio e dagli optional scelti / \*\*\* Necessario solo con Sistema Combi E/L in combinazione con Sound e/o luce colorata LED



## Schede dati delle vasche e delle vasche idromassaggio

---

## Preinstallazione Happy D.2 Plus # 700449/760449

1800 x 800 x 480

Design by sieger design

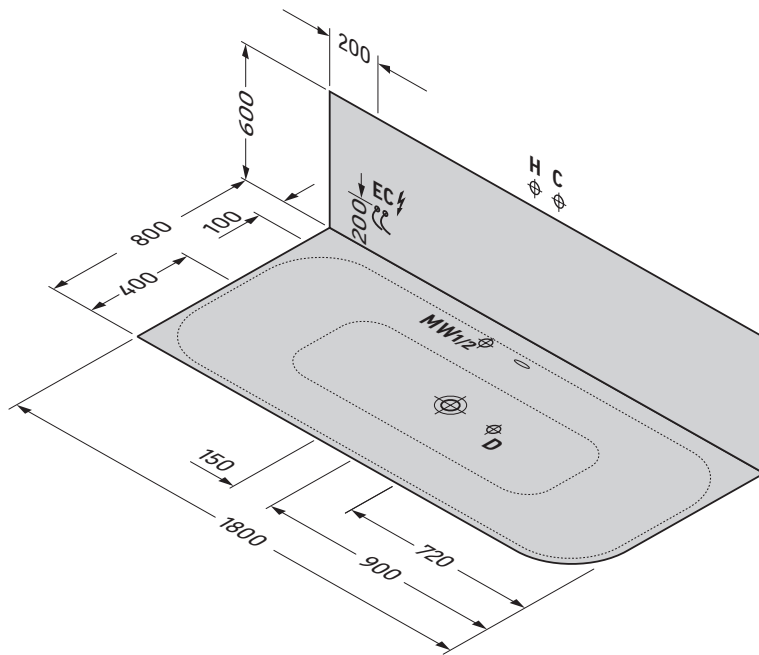

- H** Allacciamento acqua calda
- C** Allacciamento acqua fredda
- D** Allacciamento di scarico
- MW1** Allacciamento acqua miscelata per colonna di scarico con troppopieno con funzione di erogazione
- MW2** Allacciamento acqua miscelata per colonna di scarico con troppopieno con alzata dal pavimento
- EC** Allacciamento elettrico

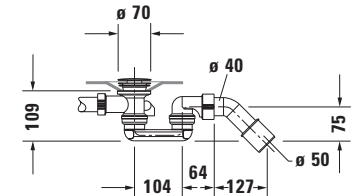

Sifone per vasca # 700449

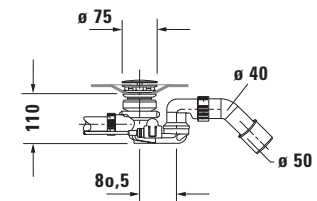

Sifone con alzata dal pavimento per vasca # 700449

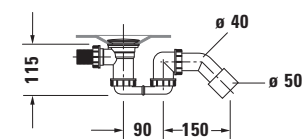

Sifone per vasca idromassaggio # 760449

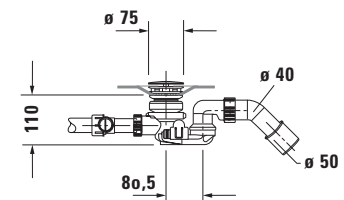

Sifone con alzata dal pavimento per vasca idromassaggio # 760449

### Dati tecnici

Peso netto kg	Carico sul pavimento kg/m <sup>2</sup>	Peso di spedizione kg	Dimensioni di spedizione cm l x p x a	Alimentazione vasca Fil. est., fil. int.	Sistema idromassaggio	Cod.Art.
54,0	197	65,5	185 x 85 x 65	3/4", 1/2"		700449 80 0 00 0000
64,0	204	79,0	201,8 x 104,8 x 73	3/4"	Sistema Air	760449 80 0 AS 0000
73,5	211	88,5	201,8 x 104,8 x 73	3/4"	Sistema Jet	760449 80 0 JS 1000
79,5 - 86,5	215 - 222	94,5 - 101,5	201,8 x 104,8 x 73	3/4"	Sistema Combi P	760449 80 0 CP 1000
92,5 - 99,5	222 - 224	105,0 - 107,5	201,8 x 104,8 x 73	3/4"	Sistema Combi E	760449 80 0 CE 1000
99,5 - 106,5	227 - 229	112,0 - 114,5	201,8 x 104,8 x 73	3/4"	Sistema Combi L	760449 80 0 CL 1000

## Preinstallazione Happy D.2 Plus # 700450/760450

1800 x 800 x 480

Design by sieger design

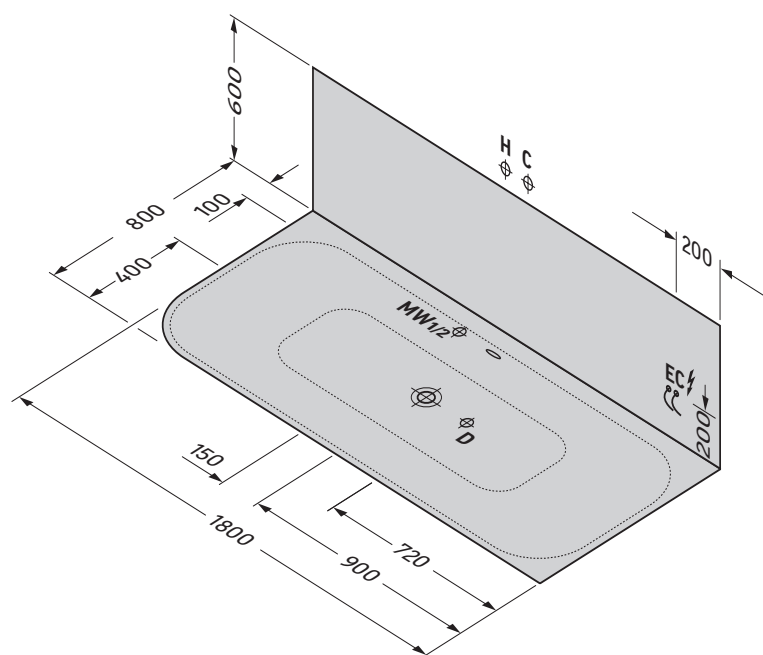

- H** Allacciamento acqua calda
- C** Allacciamento acqua fredda
- D** Allacciamento di scarico
- MW1** Allacciamento acqua miscelata per colonna di scarico con troppopieno con funzione di erogazione
- MW2** Allacciamento acqua miscelata per colonna di scarico con troppopieno con alzata dal pavimento
- EC** Allacciamento elettrico

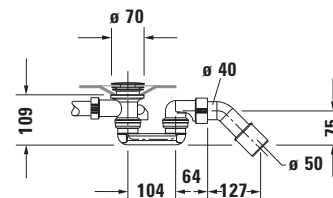

Sifone per vasca # 700450

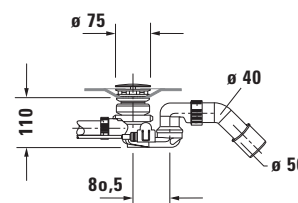

Sifone con alzata dal pavimento per vasca # 700450

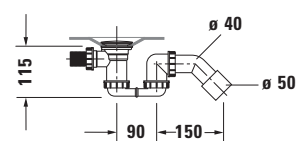

Sifone per vasca idromassaggio # 760450

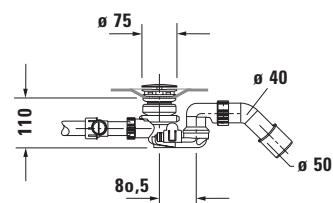

Sifone con alzata dal pavimento per vasca idromassaggio # 760450

### Dati tecnici

Peso netto kg	Carico sul pavimento kg/m <sup>2</sup>	Peso di spedizione kg	Dimensioni di spedizione cm l x p x a	Alimentazione vasca Fil. est., fil. int.	Sistema idromassaggio	Cod.Art.
54,0	197	65,5	185 x 85 x 65	3/4", 1/2"		700450 80 0 00 0000
64,0	204	79,0	201,8 x 104,8 x 73	3/4"	Sistema Air	760450 80 0 AS 0000
73,5	211	88,5	201,8 x 104,8 x 73	3/4"	Sistema Jet	760450 80 0 JS 1000
79,5 - 86,5	215 - 222	94,5 - 101,5	201,8 x 104,8 x 73	3/4"	Sistema Combi P	760450 80 0 CP 1000
92,5 - 99,5	222 - 224	105,0 - 107,5	201,8 x 104,8 x 73	3/4"	Sistema Combi E	760450 80 0 CE 1000
99,5 - 106,5	227 - 229	112,0 - 114,5	201,8 x 104,8 x 73	3/4"	Sistema Combi L	760450 80 0 CL 1000

## Preinstallazione Happy D.2 Plus # 700451/760451

1800 x 800 x 480

Design by sieger design

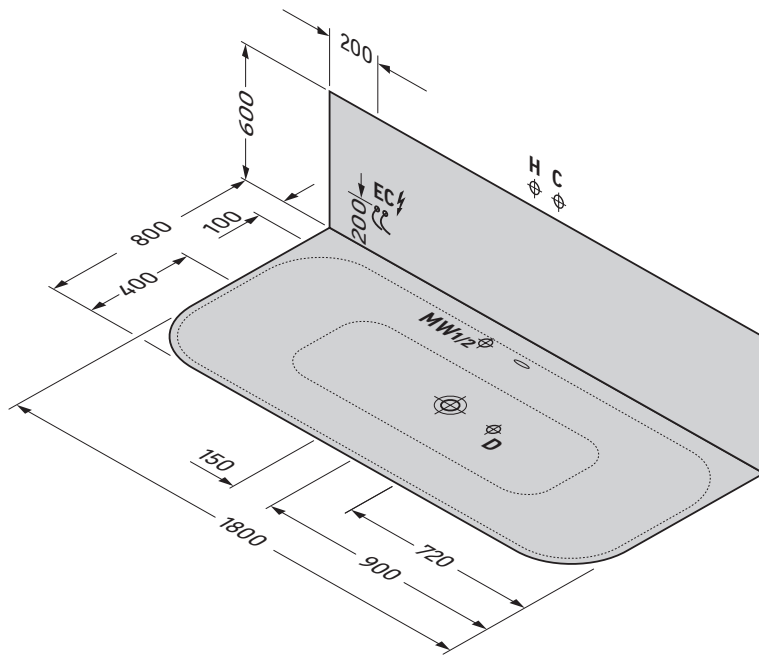

- H** Allacciamento acqua calda
- C** Allacciamento acqua fredda
- D** Allacciamento di scarico
- MW1** Allacciamento acqua miscelata per colonna di scarico con troppopieno con funzione di erogazione
- MW2** Allacciamento acqua miscelata per colonna di scarico con troppopieno con alzata dal pavimento
- EC** Allacciamento elettrico

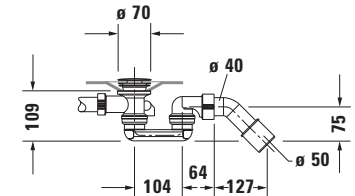

Sifone per vasca # 700451

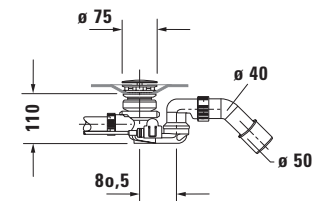

Sifone con alzata dal pavimento per vasca # 700451

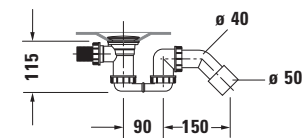

Sifone per vasca idromassaggio # 760451

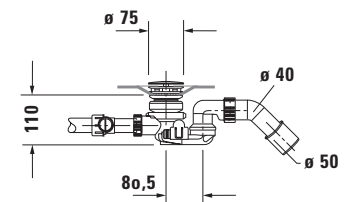

Sifone con alzata dal pavimento per vasca idromassaggio # 760451

### Dati tecnici

Peso netto kg	Carico sul pavimento kg/m <sup>2</sup>	Peso di spedizione kg	Dimensioni di spedizione cm l x p x a	Alimentazione vasca Fil. est., fil. int.	Sistema idromassaggio	Cod.Art.
58,0	200	70,0	185 x 85 x 65	3/4", 1/2"		700451 80 0 00 0000
68,0	207	83,0	201,8 x 104,8 x 73	3/4"	Sistema Air	760451 80 0 AS 0000
77,5	214	92,5	201,8 x 104,8 x 73	3/4"	Sistema Jet	760451 80 0 JS 1000
83,5 - 90,5	218 - 225	98,5 - 105,5	201,8 x 104,8 x 73	3/4"	Sistema Combi P	760451 80 0 CP 1000
96,5 - 103,5	225 - 227	109,0 - 111,5	201,8 x 104,8 x 73	3/4"	Sistema Combi E	760451 80 0 CE 1000
103,5 - 110,5	230 - 232	116,0 - 118,5	201,8 x 104,8 x 73	3/4"	Sistema Combi L	760451 80 0 CL 1000

## Preinstallazione Happy D.2 Plus # 700453/760453

1800 x 800 x 480

Design by sieger design

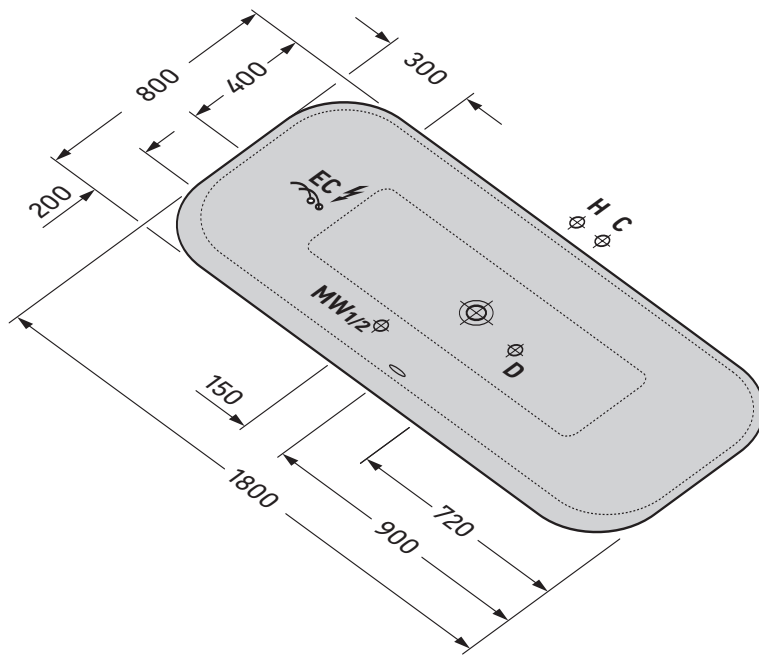

- H** Allacciamento acqua calda
- C** Allacciamento acqua fredda
- D** Allacciamento di scarico
- MW1** Allacciamento acqua miscelata per colonna di scarico con troppopieno con funzione di erogazione
- MW2** Allacciamento acqua miscelata per colonna di scarico con troppopieno con alzata dal pavimento
- EC** Allacciamento elettrico

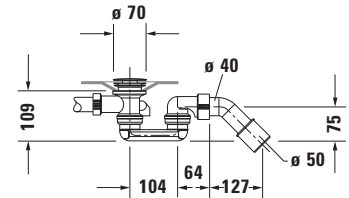

Sifone per vasca # 700453

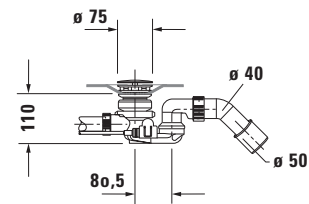

Sifone con alzata dal pavimento per vasca # 700453

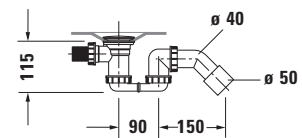

Sifone per vasca idromassaggio # 760453

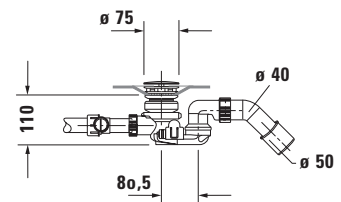

Sifone con alzata dal pavimento per vasca idromassaggio # 760453

### Dati tecnici

Peso netto kg	Carico sul pavimento kg/m <sup>2</sup>	Peso di spedizione kg	Dimensioni di spedizione cm l x p x a	Alimentazione vasca Fil. est., fil. int.	Sistema idromassaggio	Cod.Art.
66,0	206	77,5	185 x 85 x 65	3/4", 1/2"		700453 xx 0 00 0000
76,0	213	91,0	201,8 x 104,8 x 73	3/4"	Sistema Air	760453 xx 0 AS 0000

**DURAVIT AG**  
P.O. Box 240  
Werderstr. 36  
78132 Hornberg  
Germany  
Phone +49 78 33 70 0  
Fax +49 78 33 70 289  
info@duravit.com  
www.duravit.com

